

Instruction Manual
for
Drying Oven

Model DS 400
Model DS 600

Yamato Scientific Co., Ltd.

Contents

1.	PRECAUTIONS FOR INSTALLATION	1
2.	OPERATING PRECAUTIONS	3
3.	NAMES AND DESCRIPTION OF COMPONENTS	6
3.1	External View	6
3.2	Operation Panel	7
4.	OPERATION METHOD	10
4.1	Preoperational Checking	10
4.2	Fixed Temperature Operation Method	11
	* Operation from POWER Key ON	11
	* Change-over of Set Temperature during Operation	12
4.3	Auto-Start Operation Method	13
4.4	Auto-Stop Operation Method	15
4.5	Program Operation Method	17
4.6	Moving to Other Operation	19
4.7	Description of Independent Overheating Preventor	20
4.8	Description of Other Functions	21
5.	SAFETY DEVICES AND ERROR CODES	23
6.	TROUBLESHOOTING	25
7.	MAINTENANCE AND INSPECTION	26
8.	OPTIONS	27
9.	MAIN SPECIFICATIONS	29
10.	WIRING DIAGRAM	30
11.	REPLACEMENT PARTS LIST	31

1. PRECAUTIONS FOR INSTALLATION

- (1) The models DS 400/410/600/610 should be installed with adequate clearance on all sides as shown below.

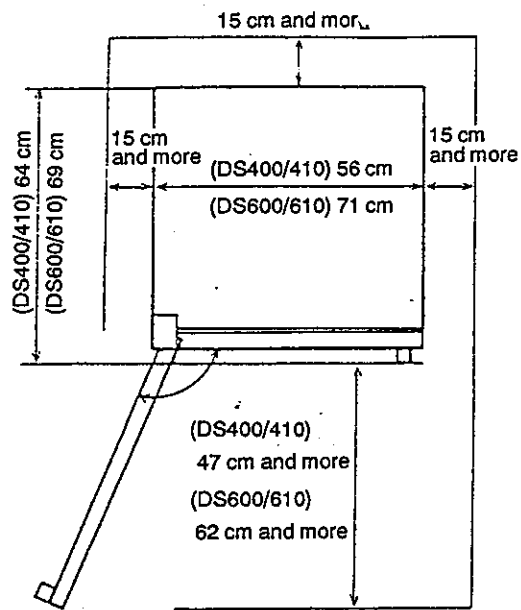

Front Side

In installing the instrument, avoid especially the following places:

- Place where there is inflammable gas or inflammable object.
- Place where it is very humid.
- Place where ambient temperature gets 35°C and more or where temperature differences severe.
- Place where it is exposed to direct sunlight.
- Place where there is much dust.

(2) Do not put anything on the main unit.

(3) Connect the power plug to the grounded receptacle which has enough power capacity for the instrument. If there is no grounded receptacles, use the optional grounding adapter and always ground the grounding lead wire.

Power plug is not attached to the instrument with the specification of 200V. Select the plug suitable to the capacity and connect it.

Colors of core wires of the power cord are white, black and green. Green cord is the grounding cable.

(4) Adjust the exhaust volume by opening and closing the cover at the exhaust port. Open the cover when the instrument is used as the oven, and close it when it is used as the thermostat.

(5) When it is used at a high temperature, the temperature of the door gets high as well. Therefore, pay well attention to the door.

(6) Connect the grounding cable to your grounding conductor or earth terminal. If no grounding conductors are available, carry out grounding operation pursuant to Article 18 of the Electric Equipment Technical Standards (Class 3 grounding work of 100Ω or less) upon consultation with the nearby electrical work undertaker.

Note

- If the instrument is not grounded, the short circuit breaker does not work at the time of short and it may cause electric shocks. It is very dangerous, therefore, always ground the instrument.
- Green cords are grounding cables. Do not connect them to the power supply, or they may cause electric shocks or damage the instrument.
- Do not connect the grounding cable to gas or water pipe.

2. OPERATING PRECAUTIONS

- (1) Never use this instrument for drying, testing, and heat treatment of explosives, inflammables or samples containing these substances as shown in Table 2.1.

Table 2.1 Unapplicable Substances

Explosives	Explosive substances	① Nitroglycol, nitroglycerin, nitrocellulose and other explosive nitric ester
		② Trinitrobenzen, trinitrotoluene, picric acid and other explosive nitro compound
		③ Peracetic acid, methyl ethyl ketone peroxide, benzoyl peroxide and other organic peroxide
Combustibles	Combustible substances	Metallic lithium, metallic potassium, metallic sodium, yellow phosphorus, phosphorus sulfide, red phosphorus, celluloid, calcium carbide (carbide), lime phosphide, magnesium powder, aluminium powder, other metal powder and sodium dithionite (hydrosulfite)
	Oxydants	① Potassium chlorate, sodium chlorate, ammonia chlorate and other chlorate
		② Potassium perchlorate, sodium perchlorate, ammonia perchlorate and other perchlorate
		③ Potassium peroxide, sodium peroxide, barium peroxide and other inorganic peroxide
		④ Potassium nitrate, sodium nitrate, ammonia nitrate and other nitrate
		⑤ Sodium chlorite and other chlorite
		⑥ Calcium hypochlorite and other hypochlorite
	Inflammable substances	① Ethyl ether, gasoline, acetaldehyde, propylene chloride, carbon disulfide and other substances with inflammation point below minus 30°C
		② Normal hexane, ethylene oxide, acetone, benzene, methyl ethyl ketone and other substances with inflammation point over minus 30°C and below 0°C
		③ Methanol, ethanol, xylene, pentyl acetate (amyl acetate) and other substances with inflammation point over 0°C and below 30°C
		④ Kerosine, light oil, turpentine oil, isopentyl alcohol (isoamyl alcohol), acetic acid and other substances with inflammation point over 30°C and below 65°C
	Combustible gases	Hydrogen, acetylene, ethylene, methane, ethane, propane, butan and other combustible substances in the form of gases at 15°C and 1 bar

(Extracted from the annexed table No. 1 in Article 6 of the Enforcement Ordinance pertaining to Labor Safety and Hygiene)

- (2) Stainless steel SUS 304 is used for the interior material, however, it may be corroded by strong acid, etc., therefore pay well attention to it. Silicone rubber is used for the packing. It may be corroded by acid, alkali, oil, halogen solvent, etc., therefore pay well attention to it.
- (3) When wet sample is treated, dewater it as much as possible before putting it in the oven.
- (4) Never put the sample on the bottom face of the unit since if the sample is directly put on the bottom face of the unit, the performance of the unit does not work and the temperature in the unit gets abnormally high and may cause troubles. Always put the sample on the attached shelf plate and set it on the shelf supports suitable for the size of the sample.
- (5) Withstand load of the shelf plate is about 15 kg in the uniformly distributed load. Put the sample in the dispersing manner as much as possible.
- (6) Place the sample on the shelf plate with the space of more than 30% in order to secure the temperature accuracy.
- (7) Pay attention so that the powder sample and small size sample do not splash. It is very dangerous if flammable substance, metal, etc. are inserted into the heater part, therefore pay special attention to it.
- (8) Use the oven in the range of 40°C to 260°C. Temperature display indicates the sensor temperature installed in the unit, however it does not always correspond to the temperature of the sample when sample volume is large or when the temperature is on the increase.
- (9) When the sample volume is large or heat load of the sample is large, it may take time for temperature to rise. Set the proper volume of the sample as occasion demands. When the heat generating sample is treated, the temperature display may get unstable.
- (10) The short circuit breaker and the independent overheating preventor are important safety units. Always perform the periodical inspections.



Refer to 7. MAINTENANCE AND INSPECTION for the inspection methods.

- (11) Always set the independent overheating preventor. Set temperature of the independent overheating preventor should be +15°C higher than the set temperature of the temperature regulator.



Refer to 4.7. HOW TO USE INDEPENDENT OVERHEATING PREVENTOR for the usage and other precautions.

- (12) When the oven is used in the high temperature operation, temperature of the door surface gets high as well, therefore pay well attention to it.
- (13) When the high temperature operation is performed, temperature of the interior, the inner surface of the door, the sample, etc. are high for some time even after the operation. Pay attention not to touch them at the time of inserting and taking out the sample. It is recommended to insert or take out the sample after operating the oven by lower set temperature or when inside temperature of the oven is lowered safe enough.
- (14) Pay well attention to the followings when the door is opened during the high temperature operation.
- * Do not touch the interior, inner surface of the door, etc. since they get very hot.
 - * If the fire alarm is installed around the oven, it may be operated incorrectly. Therefore pay attention to it.
- (15) Do not put anything on the unit.
- (16) Never use thinner and alcohols to remove the stain of the main unit. It may cause removal of paint or color change or deformation of the plastic part. At the time of cleaning, turn off the short circuit breaker on the right side face of the main unit first.
- (17) At the time of the initial operation, smoke may be generated by burning the organic substances in the heat insulating material, however, it is not the trouble of the unit.
- (18) Damage and defects due to illicit remodeling are unwarrantable.

[Note]

When you dispose of the oven,

- Don't leave it where children can reach.
- Remove the knob and hinges of the door to disable the door locking system.

3. NAMES AND DESCRIPTION OF COMPONENTS

3.1 External View

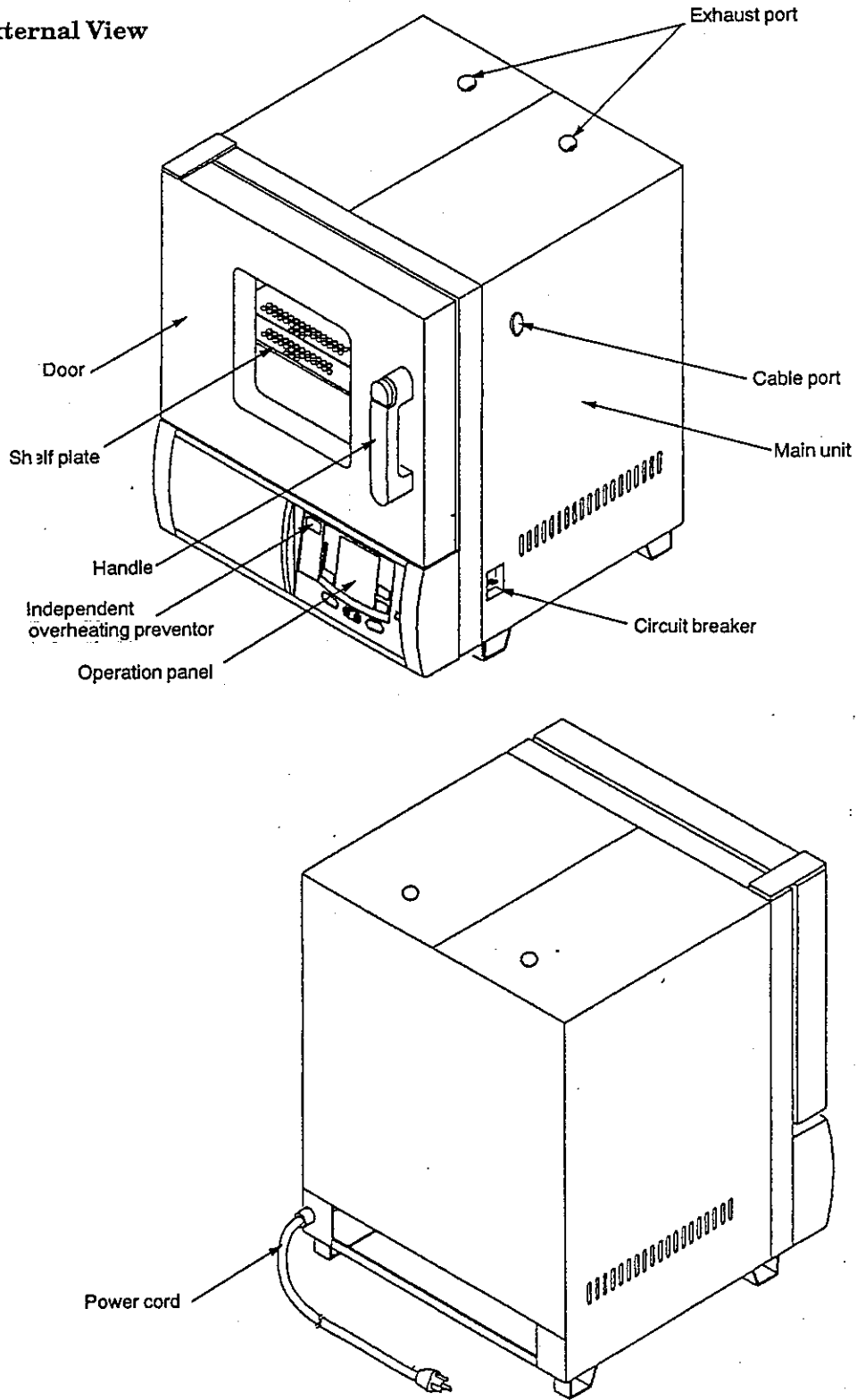

Fig. 3.1 External View

3.2 Operation Panel

Controller's operation panel is illustrated in Fig. 3.2 followed by a description of the name and functions of each part:



Refer to the attached Instruction Manual for detailed information on the specifications, functions and operation method for the controller.

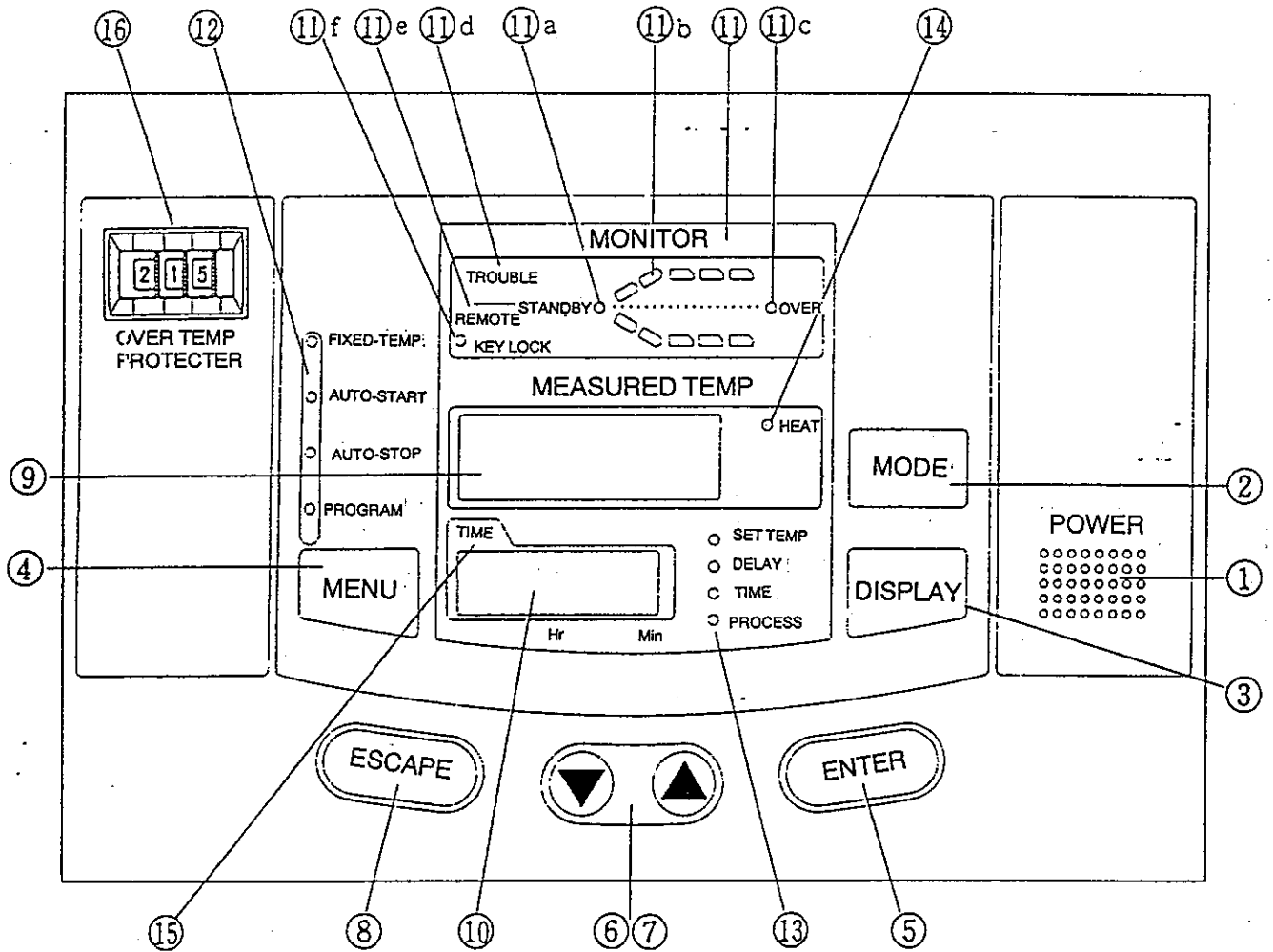

Fig. 3.2 Operation Panel

- ① POWER key : Key to change-over the controller from the standby mode to the operation mode or from the operation mode to the standby mode.
- ② MODE key : Key to select a function from program input, edit, delete modes, hour/time setting change-over mode and other functions.
- ③ DISPLAY key : Key to change-over the display content of the sub display ⑩. Display content is changed over to set temperature, remaining time, hour, execution segment No.
- ④ MENU key : Key to select the operation mode. Each mode of fixed temperature operation, auto-start operation, auto-stop operation and program operation can be selected.
- ⑤ ENTER key : Key to determining the input value of set value (temperature, time, hour, etc.), selection mode, execution segment No., etc.
- ⑥ ⑦ ▼▲(UP/DOWN) key : Key to change set value (temperature, time, hour, etc.) and to select a function from various functions on the function menu.
- ⑧ ESCAPE key : Key to cancel the latest entry and recovers the status which was valid prior to the relevant entry was made.
- ⑨ Main display : It displays temperature measurements, set values (temperature, time, hour, etc.), program information, error information, etc.
- ⑩ Sub-display : It displays set temperature, remaining time, current hour and execution segment No., etc.
- ⑪ Operation monitor : It indicates an operation mode.
- ⑪ a STANDBY lamp : It flashes to indicate that the instrument is in the pre-operational standby mode.
- ⑪ b Temperature pattern indicator: It illuminates to indicate the heat treatment process pattern executed by the controller with flashing light indicating the point currently in execution.
- ⑪ c OVER lamp : It flashes to indicate the end of auto-stop or program operation.
- ⑪ d TROUBLE indicator lamp : It blinks when an error is detected, with a literal display of "TROUBLE".

- ⑪ e REMOTE operation indicator lamp: It illuminates when the instrument is put into remote operation (optional), with a literal display of "REMOTE".
- ⑫ f KEY LOCK indicator lamp : It illuminates to indicate that the operation panel key lock function is in operation.
- ⑬ Operation menu indicator lamp : It illuminates to indicate the active operation mode in the operation menu.
- ⑭ Sub-display menu indicator lamp : It illuminates to indicate the item (set temperature, remaining time, hour or execution segment) shown in the sub-display.
- ⑮ HEAT lamp : It illuminates when the heater is on.
- ⑯ TIME indicator lamp : It illuminates when operation starting time of the auto-start, program operation is set and the operation completion time of the auto-stop is set in case that time setting is in the hour setting mode.
- ⑰ Independent overheating preventor : Setting instrument of the operation temperature of the independent over rising prevention.

4. OPERATION METHOD

Operation method for this instrument are described below: For detailed information concerning the specifications, functions and operation method for the controller which plays a leading part in operation, please refer to the Instruction Manual for Controller provided with this oven.

4.1 Preoperational Checking

(1) Power supply and grounding cable

Check if the instrument is connected to the proper power supply and the grounding cable is completely grounded.

(2) Circuit breaker

Turn on the circuit breaker. You may keep it on at all times. Perform the operation checking of the circuit breaker once a month or before the long continuous operation. Refer to 7. MAINTENANCE AND INSPECTIONS. With the circuit breaker on, the sub-display on the operation panel displays the current hour.

(3) Independent overheating preventor

Check if the independent overheating preventor is set 15°C and more higher than the inner temperature of the instrument to be used. Before long continuous operation or operation without operator at night shift, perform the operation checking of the independent overheating preventor. Refer to 7. MAINTENANCE AND INSPECTIONS.

4.2 Fixed Temperature Operation Method

Fixed temperature operation maintains a stable temperature (set temperature) during operation.

Operation from POWER Key ON

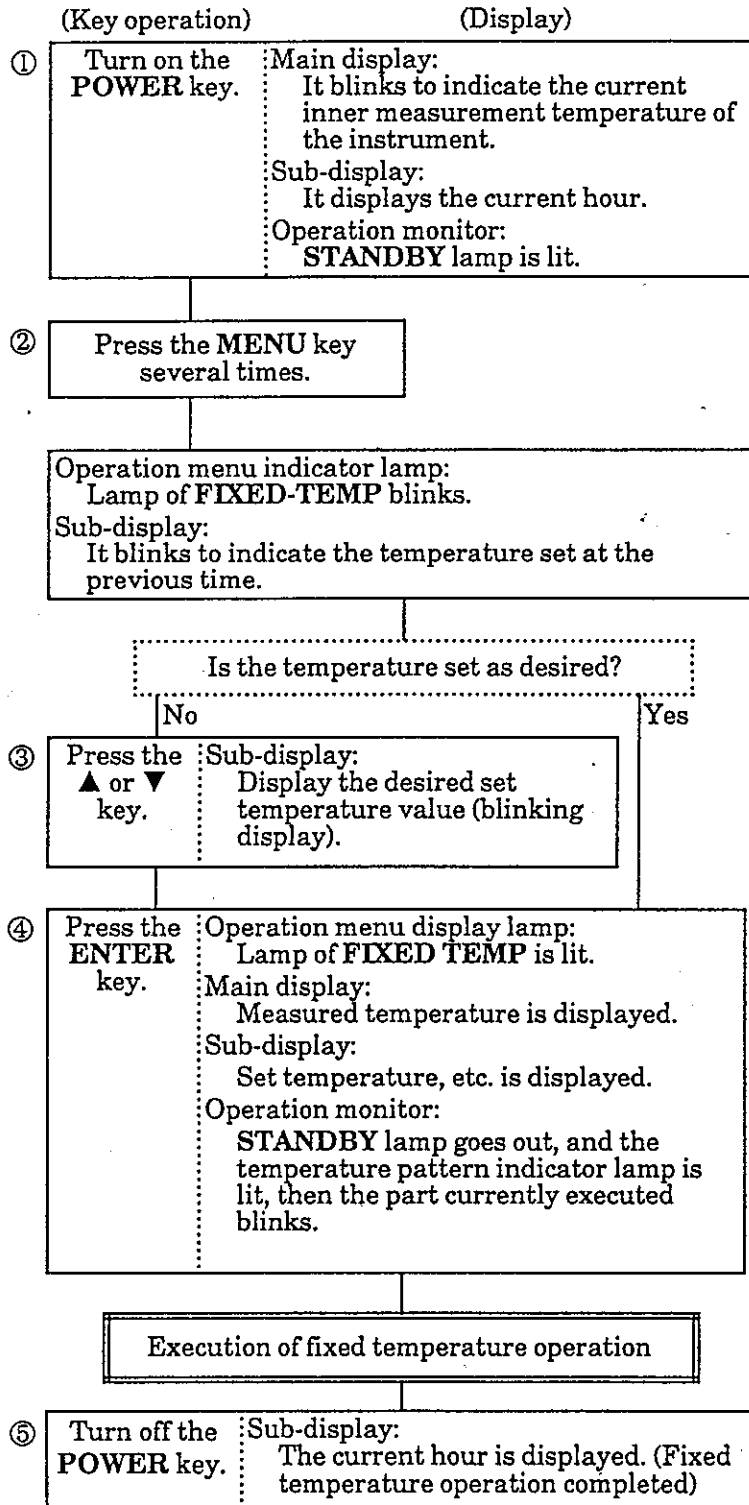

* In case of emergency, turn OFF the circuit breaker.

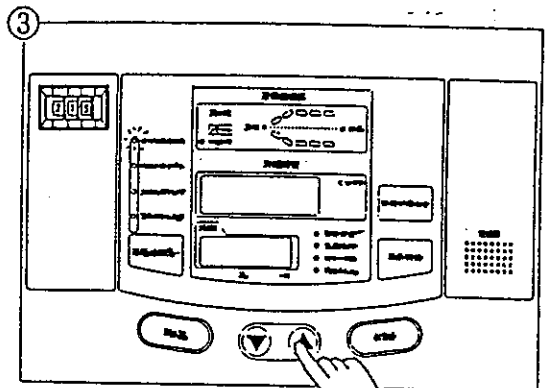
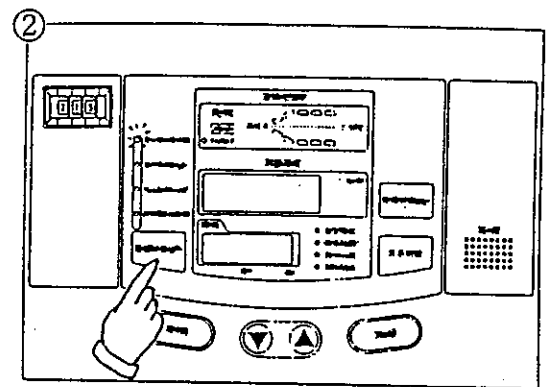
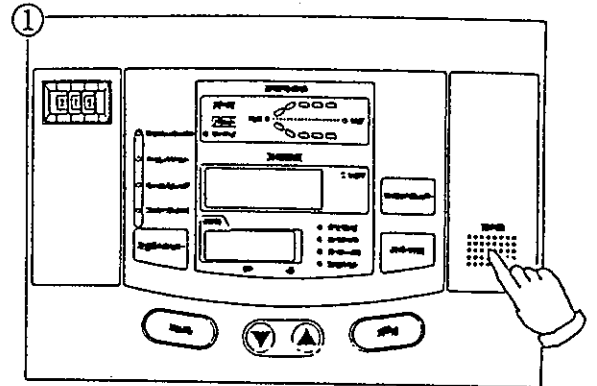

Set a desired temperature.

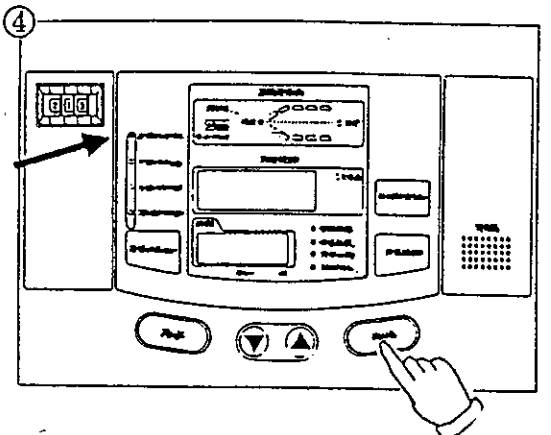

Change-over of Set Temperature during Operation

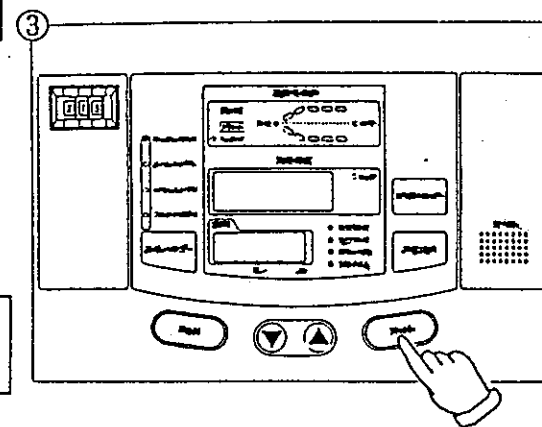
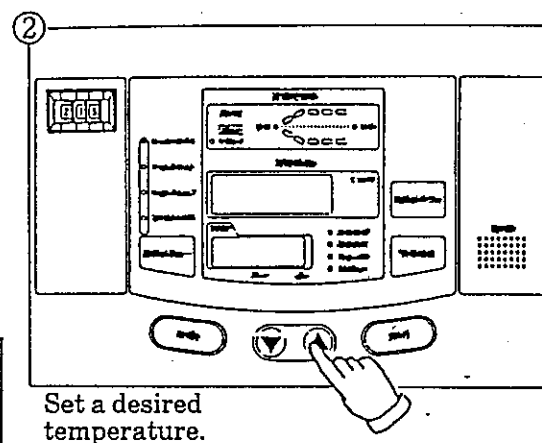
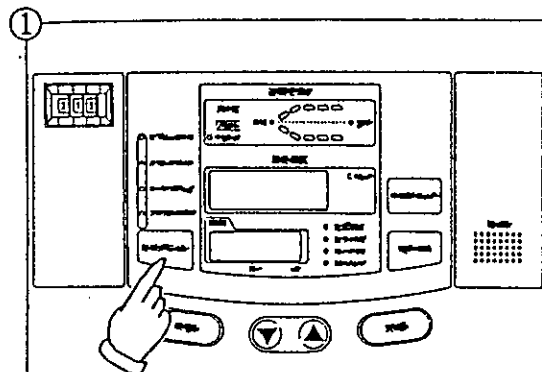
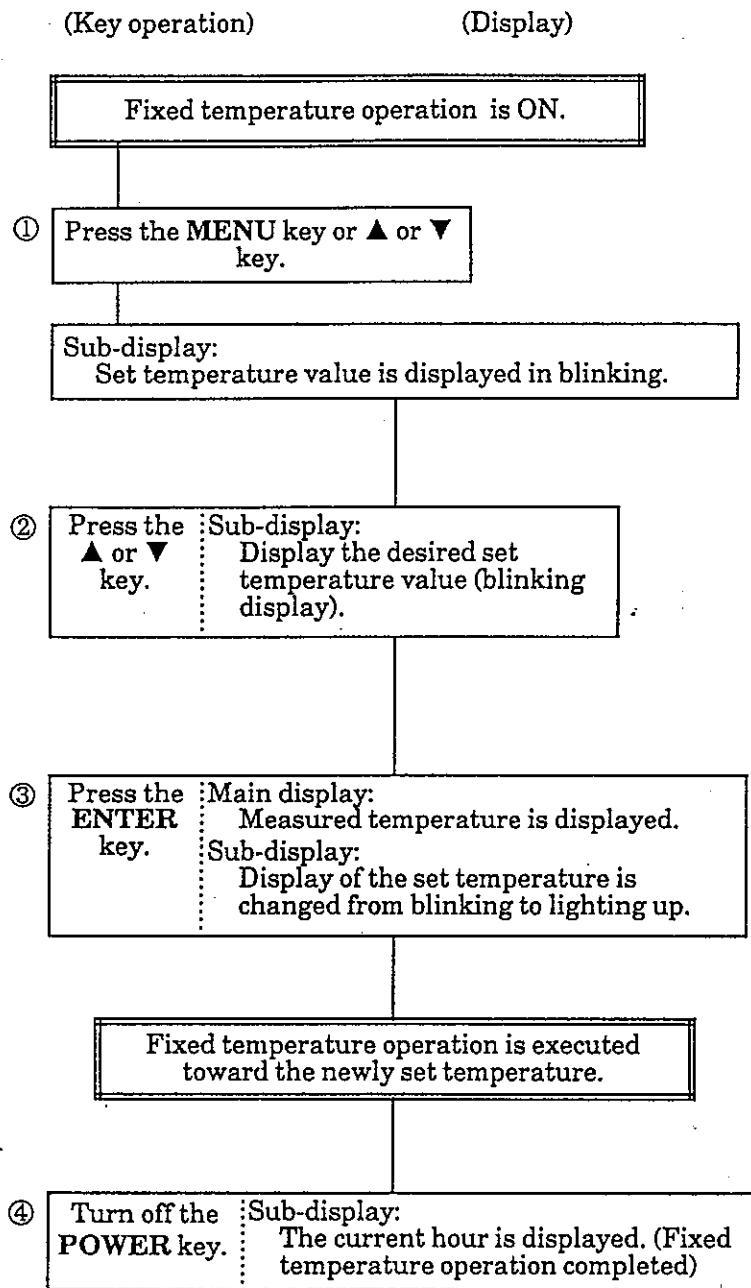

* In case of emergency, turn OFF the circuit breaker.

4.3 Auto-Start Operation Method

Auto-start operation starts fixed temperature operation when the preset period of time has elapsed or the preset time is reached.

Operation from POWER Key ON

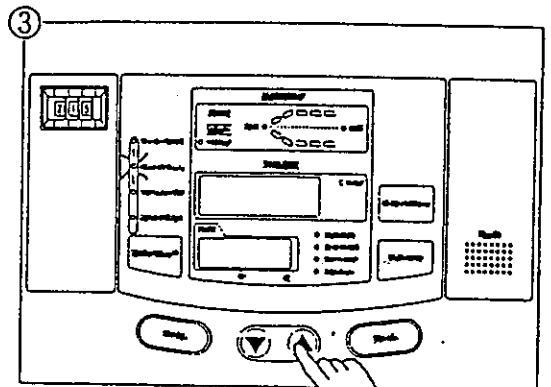
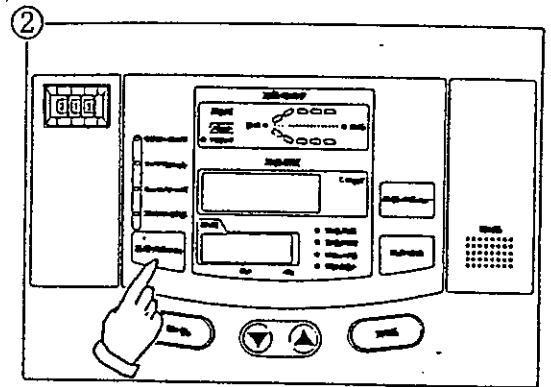
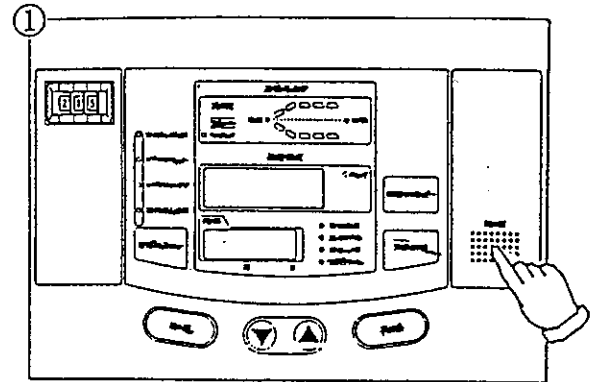
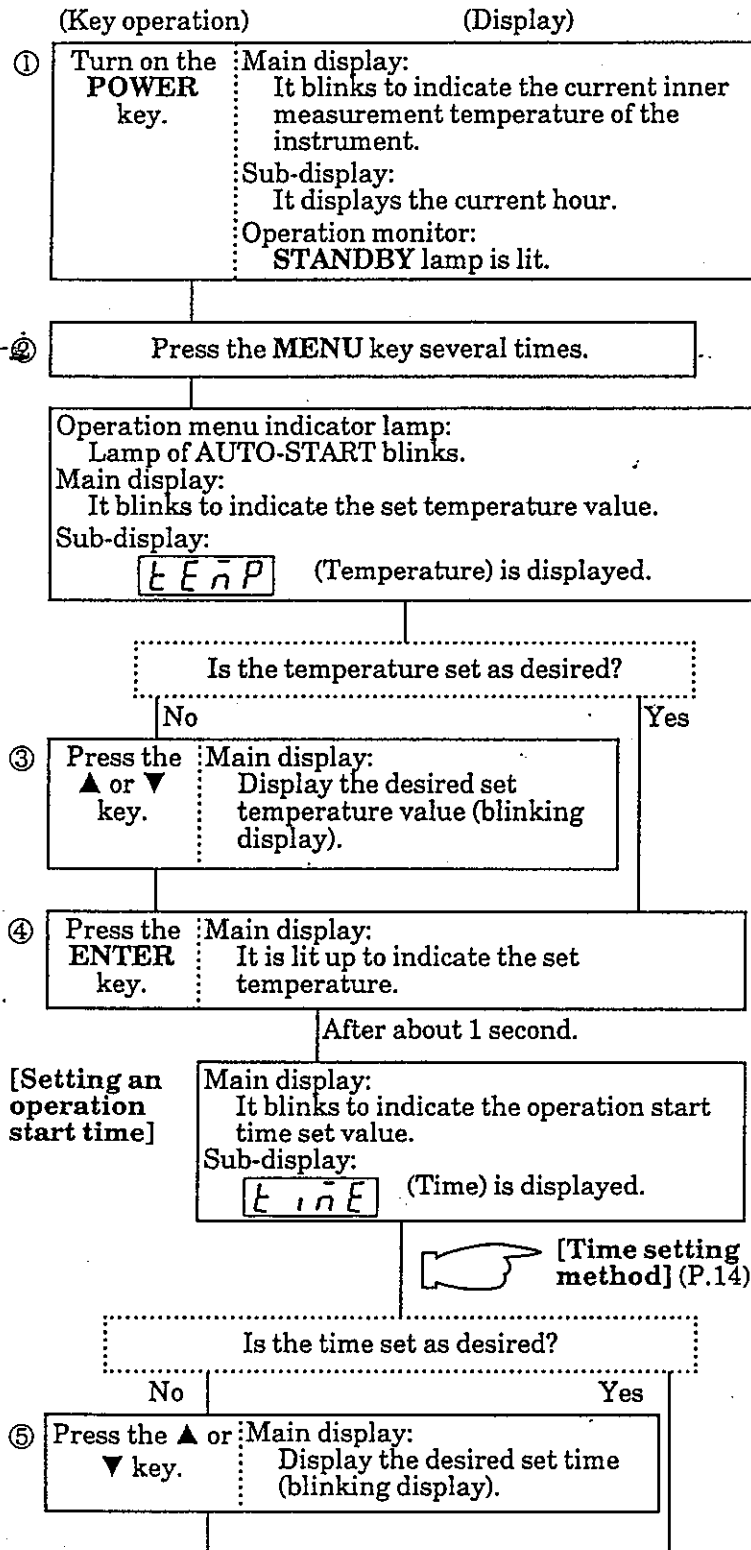

Set a desired temperature.

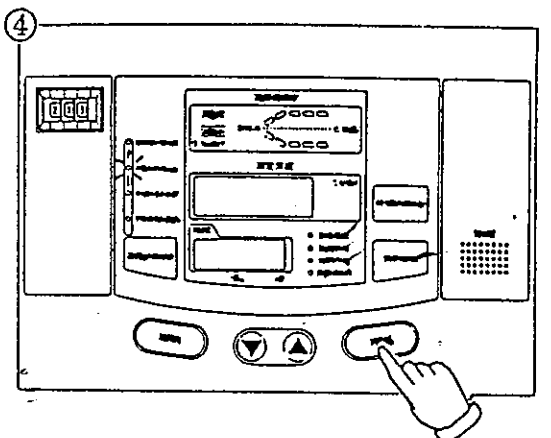

⑥ Press the **ENTER** key.

Operation menu display lamp:
Lamp of AUTO-START is lit.

Main display:
It is lit up to indicate the measured temperature.

Sub-display:
Previously set content is displayed such as remaining time and current time up to the set temperature and operation start.
→ It can be selected with the **DISPLAY** key.

Operation monitor:
STANDBY lamp starts blinking.

Operation Standby condition

Execution of auto-start operation.

Operation monitor:
Standby lamp goes out and the temperature pattern indicator blinks.

⑦ Turn off the **POWER** key.

Sub-display:
Current time is displayed (Auto-start operation completed).

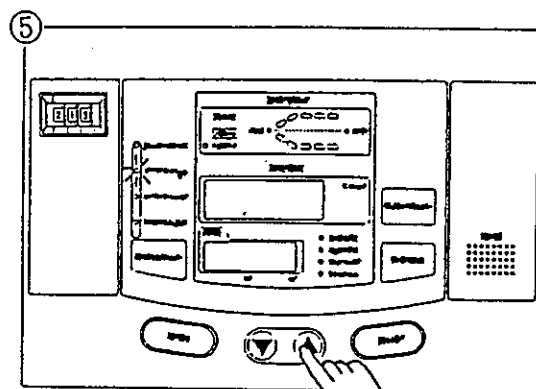

Set a desired starting time.
It can be omitted when the operation is started immediately.

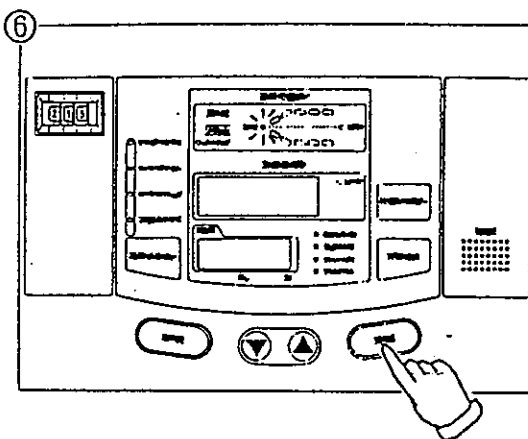

[Time setting method]

Time can be set in the form of either hour or a period of time.

- The **MODE** key is used to select the time/hour input or setting mode.
( Refer to the attached "Instruction Manual for Programmable Controller Hitech Model IV" for changing over method of time and hour.)
- Any hour within a 24 hour period can be set by entering a 4-digit number in the form of XX hr. XX min.
- In case of time, a period of time up to 999 hours can be set. Time period up to 99 hours and 59 minutes can be input in the form of XX hr. XX min. Setting it all by means of minutes is impossible. (For example, 80 minutes can not be input in lieu of 1 hour 20 minutes.) If the time period exceeds 100 hours, the end digit of the four-digit indicator is filled with a fixed display of "H". Time period exceeding 100 hours, therefore, should be set in the form of XXX hours. In other words, 100 to 999 hours are set on an hour basis.

This specification is also applicable to time setting operation as required by the ensuing auto-stop operation, etc.

4.4 Auto-Stop Operation Method

Auto-stop operation stops fixed temperature operation when the preset period of time has elapsed or the preset time is reached.

Operation from POWER Key ON

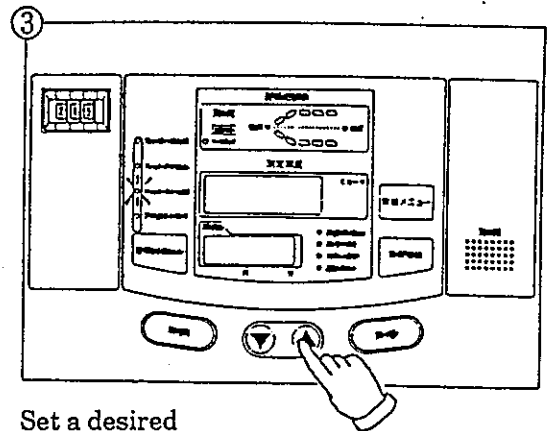
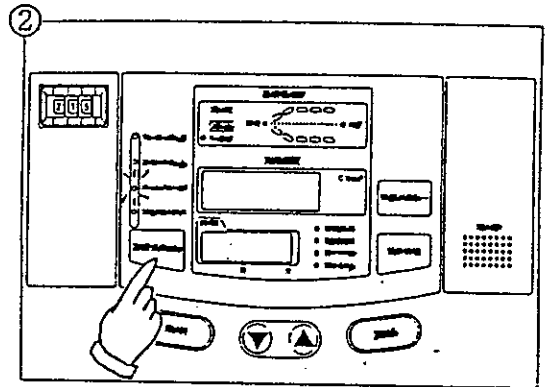
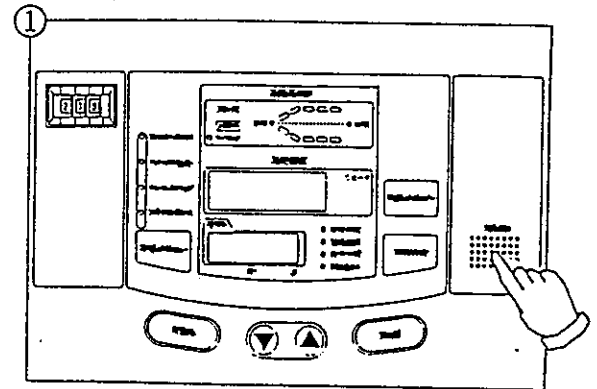
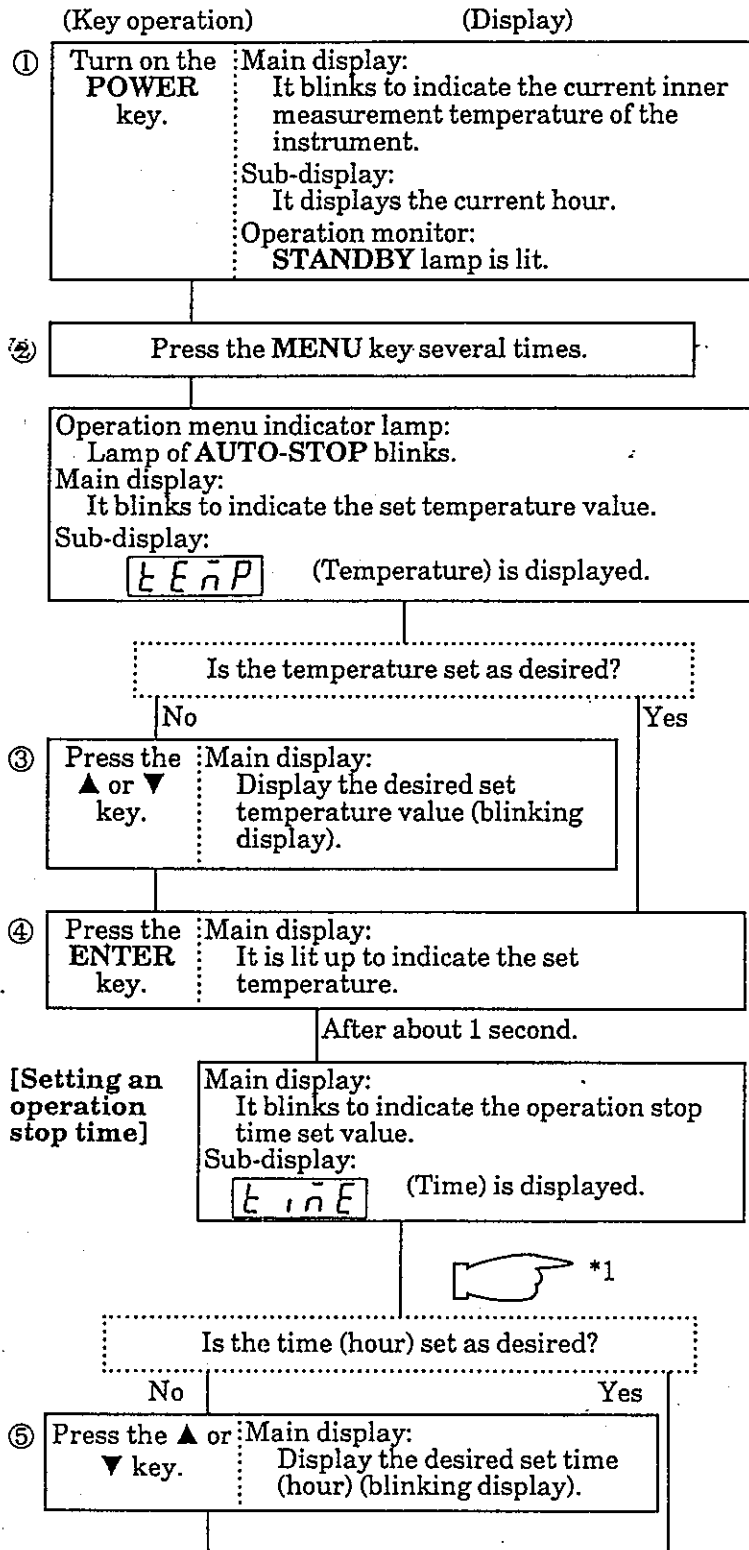

Set a desired temperature.

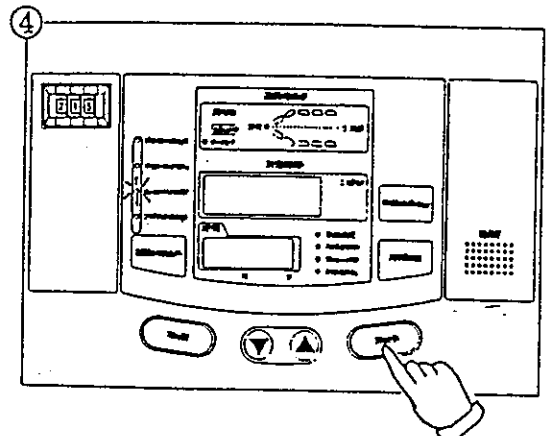

⑥ Press the **ENTER** key. Main display: It is lit up to indicate the set time (hour).

*2

If the time was set in the form of a period of time rather than hour; After about 1 second

[Selecting a wait function] Main display: Intermittent display of **OFF**. Sub-display: Displays **HR, L**.

Select **ON** or **OFF** using the **▲** or **▼** key and enter them with **ENTER** key.

Operation menu display lamp: Lamp of **AUTO-STOP** is lit.
Main display: It is lit up to indicate the measured temperature.
Sub-display: Remaining time up to the operation stop, etc. is displayed.
Operation monitor: "STANDBY" lamp goes out, and the temperature pattern indicator lamp is lit, then the part currently executed blinks.

Execution of auto-stop operation.

Expiration of auto-stop operation time
Main display : Measured temperature.
Sub-display : Current hour is displayed.
Operation monitor : **OVER** lamp blinks.

⑨ Turn off the **POWER** key. Sub-display: Current hour is displayed.

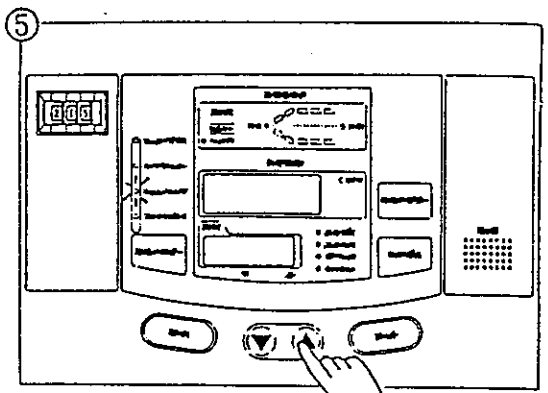

Set a desired stop time.

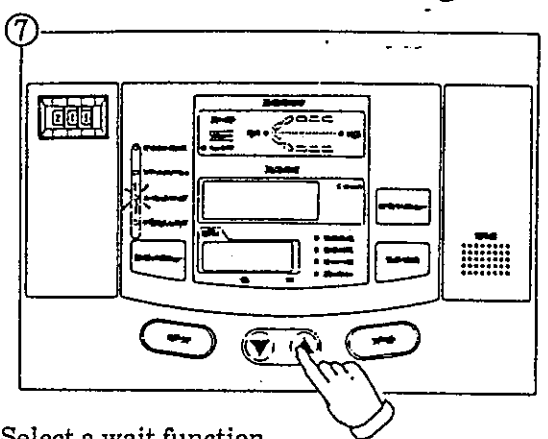
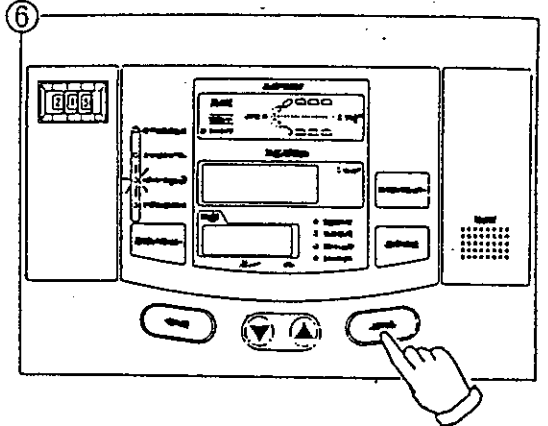

Select a wait function ON or OFF.

- *1: Refer to [Time setting method] (page 14) in the section concerning auto-start operation for the time setting method.
- *2: Auto-stop timer activates at the point of the following occasions:
 - If the wait function is on:
When the measured temperature reaches the target value.
 - If the wait function is off or the time setting represents hour:
Just after the auto-stop operation started.

4.5 Program Operation Method

In the program operation mode, this instrument is operated in accordance with the temperature and time based program. Arbitrary designation of operation start time is also possible. Further information regarding to pertinent operation method is available in the attached Instruction Manual.

Operation from POWER Key ON

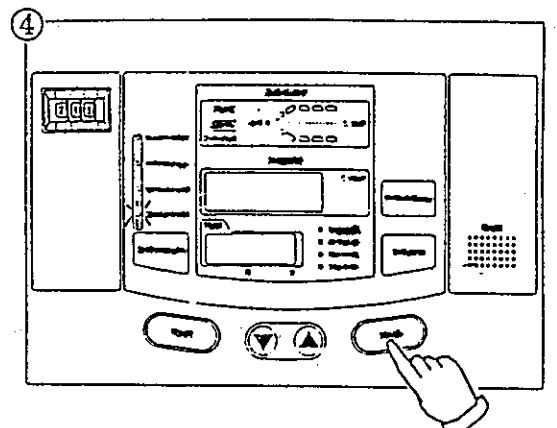
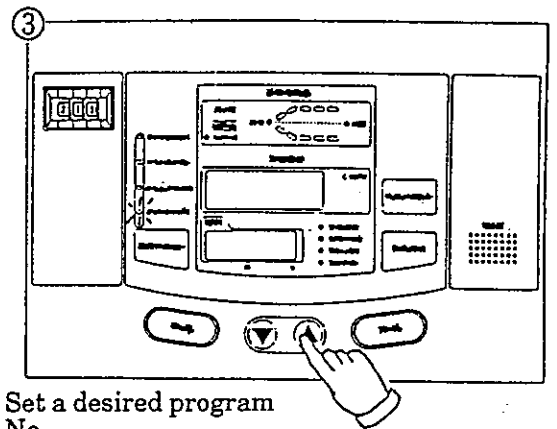
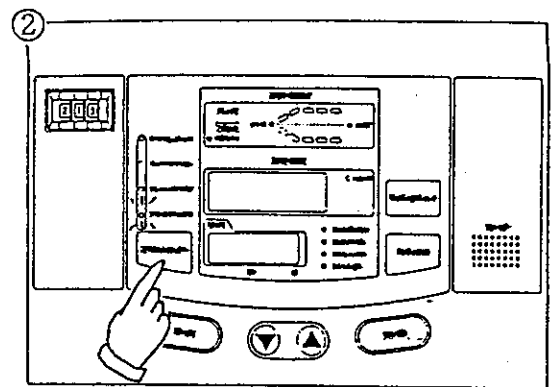
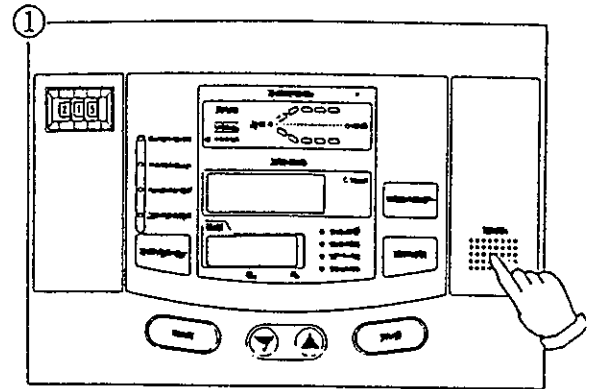
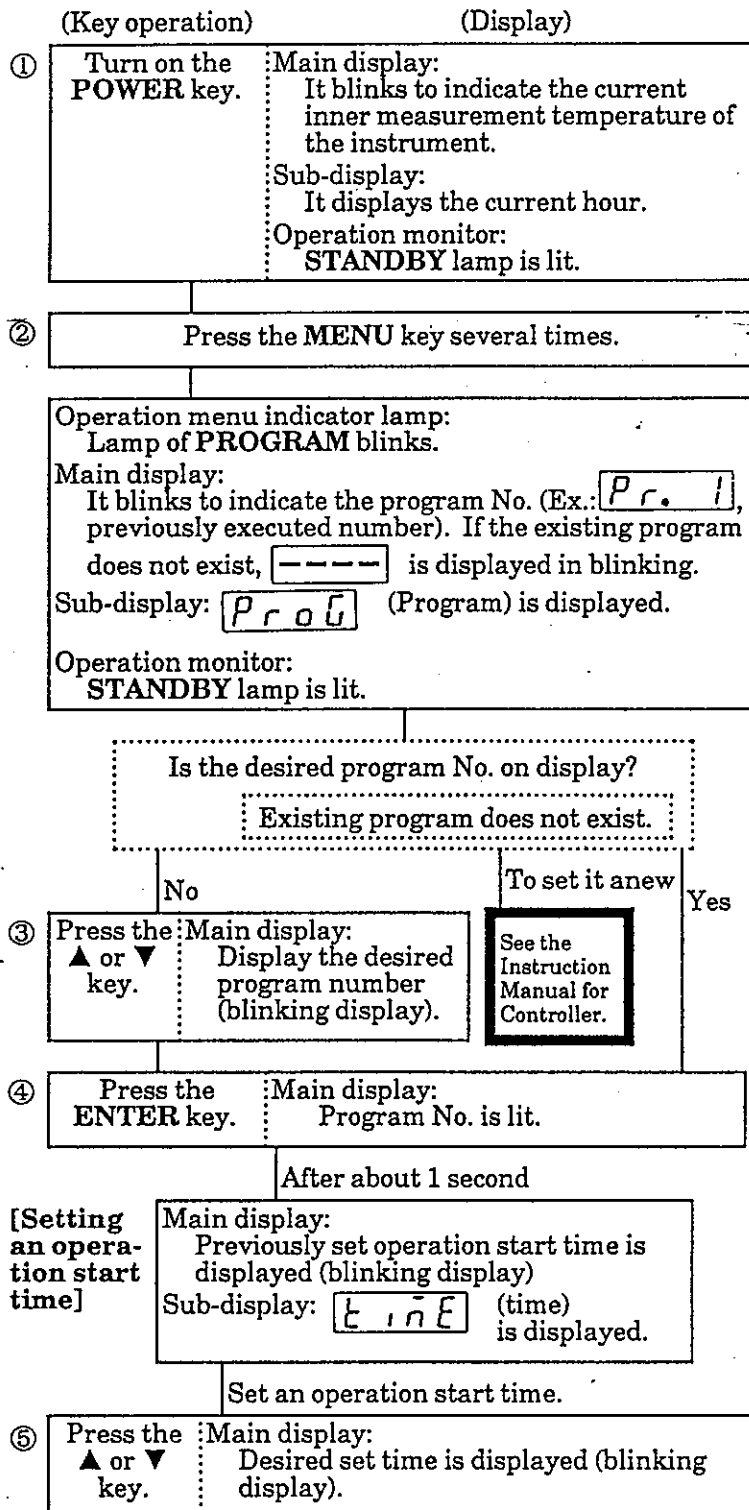

⑥ Press the **ENTER** key.

Operation menu display lamp:
Lamp of **PROGRAM** is lit.

Main display:
It is lit up to indicate the measured temperature.

Sub-display:
Previously set content is displayed such as remaining time and current time up to the set temperature and operation start.
→ It can be selected with the **DISPLAY** key.

Operation monitor:
STANDBY lamp starts blinking.

Operation Standby condition

Execution of program operation.

Operation monitor:
STANDBY lamp goes out and the temperature pattern indicator blinks.

End of program operation

Main display:
Measured temperature.

Sub-display:
Current hour or execution segment No. (end segment) is displayed.

Operation monitor:
OVER lamp blinks.

* Operations and displays as in fixed temperature operation may take place depending on the mode of termination.

⑦ Turn off the **POWER** key.

Sub-display:
Current hour is displayed.

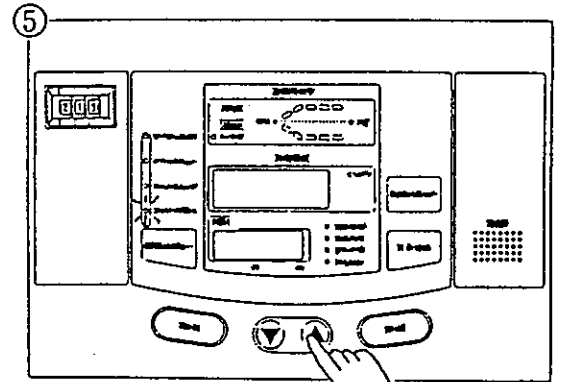

Set a desired starting time.
It can be omitted when the operation is started immediately.

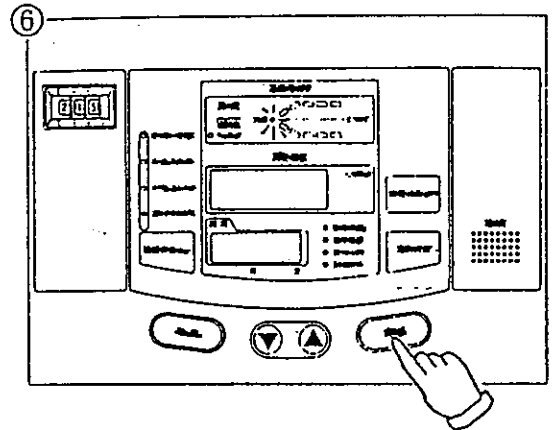

4.6 Moving to Other Operation

This instrument can be moved to the desired operation mode without stopping the current operation in any operation modes, fixed temperature operation, auto-start operation, auto-stop operation, and program operation.

① During execution of each operation

② Press MENU key several times.

Operation Menu

Display lamp:

Desired operation mode lamp flashes.
→ Since the operation is continued, currently executed operation menu display lamp is also lit.

Operation monitor:

Temperature pattern of the currently executed operation is displayed in blinking.

(When fixed temperature operation is selected)

Main display:

Current internal measured temperature is displayed.

Sub-display:

Temperature set by the previous fixed temperature operation is displayed in blinking.

(When auto-start operation is selected)

Main display:

Temperature set by the previous auto-start operation is displayed in blinking.

Sub-display:

`TEMP` (Temperature)

(When auto-stop operation is selected)

Main display:

Temperature set by the previous automatic start operation is displayed in blinking.

Sub-display:

`TEMP` (Temperature)

(When program operation is selected)

Main display:

Previously set program number. (Ex.: `Pr. 2` is displayed in blinking.)

Sub-display:

`Prog` (Program) is displayed.

Hereinafter, operate according to the operation method of the operation selected respectively (after the operation procedure ③).

(Example: Move to program operation from fixed temperature operation)

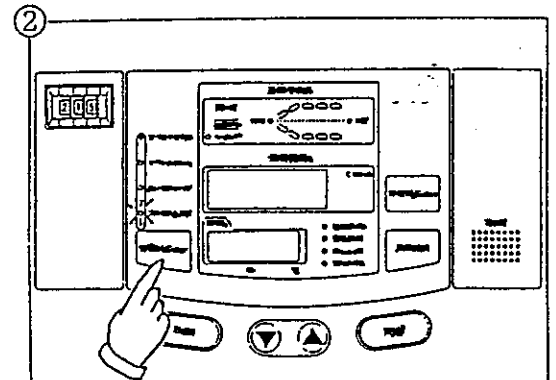
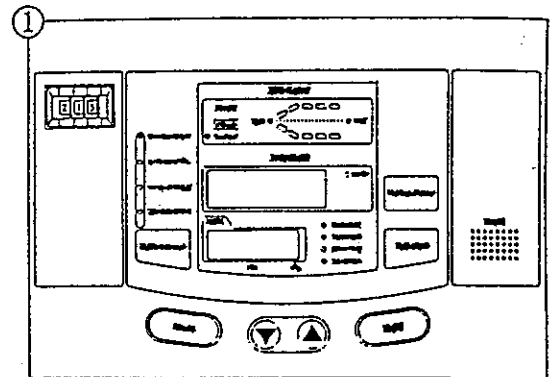

* Change-over of the operation is performed when all setting and input are completed and the operation is determined by ENTER key.

4.7 Description of Independent Overheating Preventor

There are automatic overheating preventive function of the controller (automatic recovery) and the independent overheating preventor (manual recovery) configured by circuits and sensors which are independent from the controller as the safety devices for the temperature overheating prevention in order to protect the instrument in the double countermeasures.

4.7.1 Setting Temperature Range and Function

Setting temperature range : 0 to 399°C

Input method : Three digit digital switch. Turn the drum of each column and set the desired value. However, only 0 to 3 can be input for the column of hundred.

Function : Heater output is cut off when the measured temperature gets higher than the set temperature of the independent overheating preventor. The function becomes effective in the condition of the circuit breaker ON.

When the independent overheating preventor is activated, **Er07** is displayed in blinking on the main display and TROUBLE lamp blinks. When the independent overheating preventor is activated at the time the heater is on in the temperature rising process, etc., **Er07** and **Er03** are displayed in blinking alternately.

4.7.2 Using Method

- ① Set the independent overheating preventor 15°C higher than the set temperature of the main unit normally.
- ② In setting the proper value to protect the sample, set it much higher than the room temperature, and set it 15°C and more higher than the maximum temperature set value of the temperature pattern of the operation.
- ③ When the unit is activated improperly by changing the setting of the independent overheating preventor lower than the internal temperature or by continuing operation without noticing that the setting is low, turn off the circuit breaker once and perform the setting again. When it is activated by other cause, refer to Chapter 5. SAFETY DEVICE AND ERROR CODE.

4.7.3 Cautions

- ① Only 0 to 3 can be input for the column of hundred of the digital switch by the stop mechanism, however, if it is forced to be changed to other value, it may be damaged.
- ② Set temperature may be changed by touching the setter at the time of cleaning. Always confirm that the set temperature is proper at that time or before operation.

4.8 Description of Other Functions

In addition to the functions shown heretofore, the controller of this instrument also incorporates the following functions:

A brief description of the functions is given below. Detailed information about input and setting methods can be found in the Instruction Manual for Controller.

MODE key allows you to select a desired function from the following menu:

- ① Date and current hour setting function:

Function to set the date and hour.

- ② Program deleting function:

Function to delete existing programs that are no longer necessary. Confirmation of the program content is performed in accordance with 4.5 Input/setting of Program.

* In the models DP 23/33, it is possible only when the optional program function is selected.

- ③ Hour/time setting mode select function:

Function to select either to input hour or input a period of time during time setting process in each operation mode - auto-start operation, auto-stop operation and program operation.

* It is set to the time (a period of time) setting mode when the product was shipped from the factory.

④ Key lock setting/resetting function:

Function to set or reset the key lock function that locks the POWER, MENU, ENTER, and DELETE keys of the operation panel keys to prevent incorrect entries from the operation panel keys during operation or in the standby mode. If the key lock function is set, the KEY LOCK lamp of the operation monitor is lit.

⑤ Alarm buzzer ON/OFF function:

Function to select whether or not to activate the alarm buzzer at the occurrence of an error.

* As it is set to ON when the product was shipped from the factory, the alarm buzzer sounds at the occurrence of an error.

⑥ Total time display function:

Function to display the total time during which the POWER key is on, within the range of 0 to 49999 hours.

⑦ Hold function:

Function to hold the operation which is currently executed. This function is effective only when the instrument is during operation in each operation mode of auto-start, auto-stop and program operations (including the standby condition) and when setting of operation start time of auto-start and program operations as well as the operation end time setting of automatic stop are set in the form of "Time" not in the form of "Hour".

5. SAFETY DEVICES AND ERROR CODES

This instrument incorporates an automatic diagnosis function built in the controller and safety devices independent of the controller. The purposes and operations of the safety devices and countermeasures are shown in Table 5.1. At the occurrence of an abnormal condition, an error code is displayed in the main display. Remedial action should be taken in accordance with the specified countermeasures.

Table 5.1 Purposes and Operations of Safety Device and Countermeasures

Safety device	Purpose	Response	Display	Cause and countermeasure
1. Circuit breaker	Protection from overcurrent	<ul style="list-style-type: none"> Power circuit ruptured Erases all display. 	No display	→ Report to our service section and check the cause of the problem.
2. Independent overheating preventor	Prevention of temperature overrising due to abnormality of the controller.	<ul style="list-style-type: none"> Heater circuit disconnected Activates the alarm buzzer. 	TROUBLE lamp flashes. Intermittent display of Er 07	<ul style="list-style-type: none"> Incorrect setting of the independent overheating preventor. → Set correctly. Heating of sample. → Reduce the sample. Disconnected temperature sensor for independent overheating preventor or malfunction of independent overheating preventor circuit. → Report to our service section.
3. Sensor malfunction detector	Prevention of overheating due to a malfunction of sensor	<ul style="list-style-type: none"> Heater circuits disconnected Activates the alarm buzzer. 	TROUBLE lamp flashes. Intermittent display of Er 01	<ul style="list-style-type: none"> Break in temperature sensor circuit → Report to our service section.
4. Disconnected heater circuit detector	Warning impossible temperature control	<ul style="list-style-type: none"> Heater circuits disconnected. Activates the alarm buzzer. 	TROUBLE lamp flashes. Intermittent display of Er 03	<ul style="list-style-type: none"> Open circuit in heater → Report to our service section.
5. Triac short circuit detector	Prevention of overheating by uncontrollable heater	<ul style="list-style-type: none"> Heater circuit disconnected Activates the alarm buzzer. 	TROUBLE lamp flashes. Intermittent display of Er 02	<ul style="list-style-type: none"> Short circuit in triac → Report to our service section.
6. Main relay malfunction detector	Breaking heater circuit Warning a malfunction	<ul style="list-style-type: none"> Activates the alarm buzzer. 	TROUBLE lamp flashes. Intermittent display of Er 10	<ul style="list-style-type: none"> A malfunction of main relay → Report to our service section.
7. POST function*	Operation check of the controller.	<ul style="list-style-type: none"> Heater circuits disconnected. Activates the alarm buzzer. 	TROUBLE lamp flashes. Intermittent display of Er 09 Er 14 Er 15	→ Report to our service section.

Safety device	Purpose	Response	Display	Cause and countermeasure
8. Automatic overheating preventive function	Prevention of overheating	<ul style="list-style-type: none"> • Heater circuit disconnected. 	No display of error mode	<ul style="list-style-type: none"> • Heating of samples → Reduce samples.
9. Key lock	Prevention of incorrect operation	<ul style="list-style-type: none"> • Any entries other than the MODE key are inhibited. 	Key lock display lamp lights up.	<ul style="list-style-type: none"> • This function prevents the disruption of operation due to incorrect operation. Leave it on during operation. See the attached Instruction Manual for Controller for its setting and resetting methods.
10. Memory backup circuit	Saving settings in memory at the time of power failure		No display	

Note: At the activation of the safety devices 1 to 7 above, be sure to shut down the circuit breaker. If heat radiation is responsible for the activation of any safety devices, take necessary remedial action before reactivating the circuit breaker. This resets the safety circuit to recover the normal status.

* POST (Power On Self Test) function checks the microprocessor, memory, surrounding LSI, surrounding circuit of the controller every time "POWER" key is turned ON. This function checks if there is no fatal malfunction of the controller before starting the operation.

6. TROUBLESHOOTING

Troubleshooting methods are shown in Table 6.1.

Regarding the operations of the safety devices and countermeasures, refer to Chapter 5. Safety Devices and Error Codes.

Table 6.1 Troubleshooting Methods

Trouble	Cause	Countermeasure
No display of current hour in the sub-display at the activation of circuit breaker.	<ul style="list-style-type: none"> • Power disconnection. • Defective circuit breaker. • Defective controller. 	<ul style="list-style-type: none"> • Confirm power connection before turning on the power. • Replace the circuit breaker. (*) • Replace the controller. (*)
No display on the operation panel when the POWER key is pressed.	<ul style="list-style-type: none"> • Faulty power supply. • Defective controller. 	<ul style="list-style-type: none"> • Connect a proper power supply. • Replace the controller. (*)
No increase in temperature.	<ul style="list-style-type: none"> • Safety devices of the independent overheating preventor and self diagnosis function are activated and the heater circuit is cut off (error code display). 	<ul style="list-style-type: none"> • Refer to Chapter 5. Safety Devices. (*)
It takes too much time for temperature to rise.	<ul style="list-style-type: none"> • Volume of sample is too much. • Defective controller. • Defective temperature sensor. 	<ul style="list-style-type: none"> • Refer to the Item 9 in Chapter 2. OPERATING PRECAUTIONS. • Replace the controller. (*) • Replace the temperature sensor. (*)
Unstable temperature display.	<ul style="list-style-type: none"> • Volatile ambient temperature. • Effect of samples. • Defective controller. • Defective temperature sensor. 	<ul style="list-style-type: none"> • Refer to Chapter 1. PRECAUTIONS FOR INSTALLATION. • Refer to the Item 9 in Chapter 2. OPERATING PRECAUTIONS. • Replace the controller. (*) • Replace the temperature sensor. (*)

Concerning the above items marked with (*) and countermeasures for any troubles other than shown in Table 6.1, consult the store you purchased this product or the nearest Yamato Scientific Co., Ltd. or Yamato Engineering Co., Ltd.

Please contact:

Yamato Engineering Co., Ltd.:

Tokyo 03-3663-9351

Osaka 06-365-7012

Nagoya 052-881-2854

7. MAINTENANCE AND INSPECTION

Periodical implementation of simple maintenance and inspection routines as shown below is required to enable maximum use of this instrument.

7.1 Operation Check of Circuit Breaker

Perform the check of the circuit breaker in the following procedures.

Turn the operation lever ON, then press the test button (red) with the tip of the ball point pen, etc. It is normal if it is turned OFF right away at this time. Turn the operation lever ON again to return it to the normal condition.

- In case it does not become OFF when the test button is pressed, confirm if the power on the primary side is normally connected.

After checking, turn it ON. It is all right to keep the circuit breaker ON normally. Check the circuit breaker once a month or before the long continuous operation.

7.2 Operation Check of Independent Overheating Preventor

After executing the fixed temperature operation at the set temperature 0°C, set the operation temperature of the independent overheating preventor to 0°C. When it is normal, the heater circuit is cut off in a few seconds and TROUBLE lamp and Er01 flashes at the same time, and the alarm buzzer sounds if the alarm buzzer function is ON.

After confirming, turn off the circuit breaker once, then return the setting of the independent overheating preventor to the proper value.

Always perform inspection before the long continuous operation or the operation without a operator at night shift.

8. OPTIONS

A variety of optional functions are available for Fixed Temperature Dryer DS series.

A brief description of these functions is given below. The following optional functions from (2) to (7) are, however, incapable of installation after delivery.

(1) Interface RC23 for connecting personal computer (with AC adaptor)

The controller of the instrument incorporates the communication function RS422A, therefore, if the interface RC23 is connected, this instrument can be controlled from the personal computer through the RS232C terminal of the personal computer.

Several ovens can be remote controlled by one personal computer.

(2) Digital printer DGP 4

The controller of the instrument incorporates the printer interface, therefore, if the digital printer is connected, the operation condition of the oven can be printed out and recorded in digital.

Power is supplied separately from the main unit with the specification of 100V. It is installed separately from the main unit.

(3) Temperature output terminal

This terminal outputs temperature measurement sensor signal to outside the instrument. Voltage of 5 mV per 1°C (0V at 0°C) is output, therefore, if it is connected to the proper recorder, recording and control of the inner temperature can be performed.

(4) Time-up output terminal

This terminal outputs contact signal at the end of automatic stop operation or program operation.

(5) External alarm terminal

At the occurrence of an abnormal condition during operation (when the TROUBLE lamp of the controller starts flashing), this terminal outputs error signal to outside the instrument.

- (6) Wind speed variable function

Rotation speed of the fan motor can be set in 10 steps.

- (7) Addition of cable port
- (8) Door right side open specification
- (9) Frame
- (10) Piling fittings
- (11) Shelf plate

9. MAIN SPECIFICATIONS

Model (Provisional)		DS400	DS600
System		Natural convection	
Performance	Operating temperature range	40 to 260°C	
	Temperature adjustment accuracy	±1°C (@260°C)	
	Temperature distribution accuracy	±10°C (@260°C)	
	Maximum temperature reaching time	Approx. 75 minutes	
Components	Temperature controller	PID control by microcomputer (Hitech Model IV Type 4)	
	Temperature sensor	K thermocouple (double sensor)	
	Interior lining	Stainless steel SUS 304	
	Heater System Capacity	1.2 kW	1.36 kW
	Heat insulating material	Glass wool	
	Observation window	250 × 280 mm reinforced glass 3 mm	
	Cable port	Inner diameter 30 mm (right side face)	
	Exhaust port	Inner diameter 30 mm × 2 (upper face)	
Function	Operation/display functions	Fixed temperature operation, auto-start operation, auto-stop operation, program operation (16 segments), temperature, time digital setting (communication type input), digital display, current hour display, operation monitor (operation condition graphic display by LED patterns)	
	Additional functions	Calendar timer, integrating time	
Safety countermeasures		Self diagnosis functions (sensor, heater, triac, automatic overheating prevention) Independent overheating preventor, key lock function Circuit breaker	
Standards	Internal dimensions W × D × H mm	450 × 490 × 450	600 × 540 × 500
	External dimensions W × D × H mm	560 × 601 × 820	710 × 651 × 870
	Internal capacity	99 liters	162 liters
	Shelf plate withstand load	Approx. 15 kg/piece	
	Shelf bracket step number	11 steps	13 steps
	Shelf bracket pitch	30 mm	
	Power source 50/60 Hz	115V, 13A 220V single phase, 6.5A	115V, 14.5A 220V single phase, 7.5A
	Weight	Approx. 48 kg	Approx. 63 kg
Accessories	Shelf plate/ Shelf bracket	2 sets	2 sets
Standard option		External communication function (RS422A), external communication adapter (RS232C convert), temperature output terminal, external alarm terminal, time up output terminal, digital printer, frame, piling fittings, shelf plate, additional cable hole, door right hand opening specification	

9. MAIN SPECIFICATIONS

Model (Provisional)		DS400	DS600
System		Natural convection	
Performance	Operating temperature range	40 to 260°C	
	Temperature adjustment accuracy	±1°C (@260°C)	
	Temperature distribution accuracy	±10°C (@260°C)	
	Maximum temperature reaching time	Approx. 75 minutes	
Components	Temperature controller	PID control by microcomputer (Hitech Model IV Type 4)	
	Temperature sensor	K thermocouple (double sensor)	
	Interior lining	Stainless steel SUS 304	
	Heater System Capacity	1.2 kW	1.36 kW
	Heat insulating material	Glass wool	
	Observation window	250 × 280 mm reinforced glass 3 mm	
	Cable port	Inner diameter 30 mm (right side face)	
	Exhaust port	Inner diameter 30 mm × 2 (upper face)	
Function	Operation/display functions	Fixed temperature operation, auto-start operation, auto-stop operation, program operation (16 segments), temperature, time digital setting (communication type input), digital display, current hour display, operation monitor (operation condition graphic display by LED patterns)	
	Additional functions	Calendar timer, integrating time	
Safety countermeasures		Self diagnosis functions (sensor, heater, triac, automatic overheating prevention) Independent overheating preventor, key lock function Circuit breaker	
Standards	Internal dimensions W × D × H mm	450 × 490 × 450	600 × 540 × 500
	External dimensions W × D × H mm	560 × 601 × 820	710 × 651 × 870
	Internal capacity	99 liters	162 liters
	Shelf plate withstand load	Approx. 15 kg/piece	
	Shelf bracket step number	11 steps	13 steps
	Shelf bracket pitch	30 mm	
	Power source 50/60 Hz	200V 100V, 13A single phase, 6.5A	200V 100V, 14.5A single phase, 7.5A
	Weight	Approx. 48 kg	Approx. 63 kg
Accessories	Shelf plate/ Shelf bracket	2 sets	2 sets
Standard option		External communication function (RS422A), external communication adapter (RS232C convert), temperature output terminal, external alarm terminal, time up output terminal, digital printer, frame, piling fittings, shelf plate, additional cable hole, door right hand opening specification	

DS410 220V 7.5A

Wiring Diagram

(DS400/600 AC100V)

(DS410/610 AC200V)

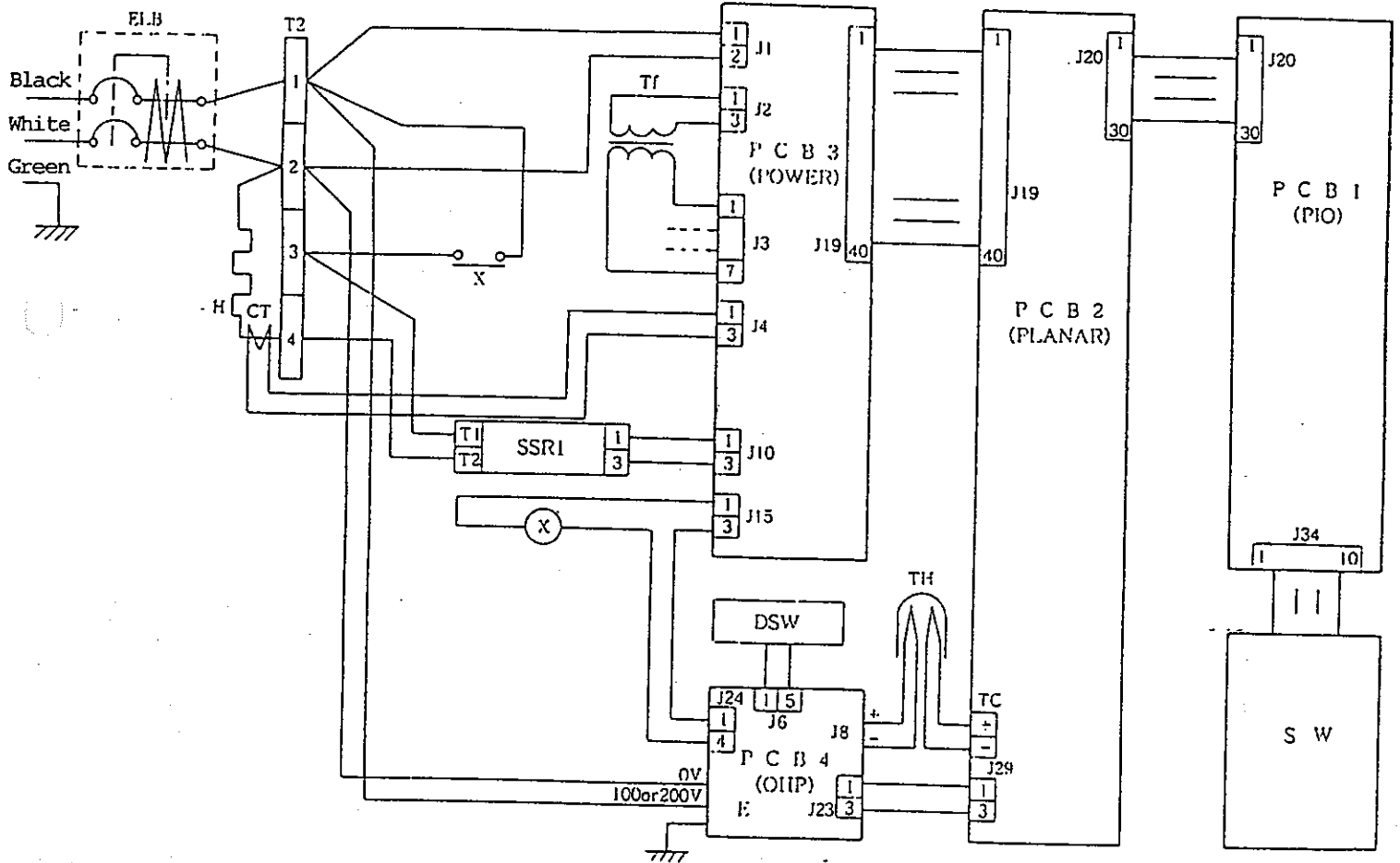

Symbol	Part name
CT	Current transformer
DSW	Digital switch
ELB	Short circuit breaker
H	Heater
PCB1	Planar board 1
PCB2	Planar board 2
PCB3	Planar board 3
PCB4	Planar board 4 (Independent overheat prevention)
SSR1	TRIAC unit 1
SW	Sheet switch
T2	Terminal block
Tf	Transformer
TH	Thermocouple (double sensor)
X	Main Relay

R e p l a c e m e n t P a r t s L i s t

DS 4 0 0

Symbol	Part name	Cord No.	Specification
H	Heater	DS63S-40190	100V, 600W
P	Plug	2-13-001-0005	T2-3b
PIO	Display board	1-24-000-0024	Model HiTEC IV CR
PLANAR	Planar board	1-24-000-0023	Model HiTEC IV CR
SSR1	Solid-state relay	2-16-000-0010	SSR-01.
ELB	Bleaker	2-06-005-0010	BJS-153
TF	Transformer	2-18-000-0022	AC100V, HiTEC IV CR
T4	Terminal block	2-07-000-0004	F1112-250-6-4P
TH	Thermocouple	1-16-001-0023	K-thermocouple (double sensor)
X1	Relay	2-05-012-0001	JA1a-TM-DC12V
POWER1	Power board	1-24-000-0025	HiTEC IV CR
CT	Current transformer	2-17-001-0002	CLT-6-S-400
SW	Sheet switch	1-01-320-0001	Type 4H
OH	Independent overheat prevention device	1-27-001-0002	

DS 4 1 0

Symbol	Part name	Cord No.	Specification
H	Heater	DS63S-40190	100V, 600W
P	Plug	2-13-001-0008	T2-3b
PIO	Display board	1-24-000-0024	Model HiTEC IV CR
PLANAR	Planar board	1-24-000-0023	Model HiTEC IV CR
SSR1	Solid-state relay	2-16-000-0010	SSR-01.
ELB	Bleaker	2-06-005-0010	BJS-153
TF	Transformer	2-18-000-0023	AC200V, HiTEC IV CR
T4	Terminal block	2-07-000-0004	F1112-250-6-4P
TH	Thermocouple	1-16-001-0023	K-thermocouple (double sensor)
X1	Relay	2-05-012-0011	JA1a-TM-DC12V
POWER1	Power board	1-24-000-0025	HiTEC IV CR
CT	Current transformer	2-17-001-0002	CLT-6-S-400
SW	Sheet switch	1-01-320-0001	Type 4H
OH	Independent overheat prevention device	1-27-001-0002	

R e p l a c e m e n t P a r t s L i s t

DS600

Symbol	Part name	Cord No.	Specification
H	Heater	DS63S-40190	100V, 680W
P	Plug	2-13-001-0006	T2-3b
PIO	Display board	1-24-000-0024	Model HiTEC IV CR
PLANAR	Planar board	1-24-000-0023	Model HiTEC IV CR
SSR1	Solid-state relay	2-16-000-0010	SSR-01.
ELB	Bleaker	2-06-005-0011	BJS-203
TF	Transformer	2-18-000-0022	AC100V, HiTEC IV CR
T4	Terminal block	2-07-000-0004	F1112-250-6-4P
TH	Thermocouple	1-16-001-0023	K-thermocouple (double sensor)
X1	Relay	2-05-012-0010	HE1-DC12V
POWER1	Power board	1-24-000-0025	HiTEC IV CR
CT	Current transformer	2-17-001-0002	CLT-6-S-400
SW	Sheet switch	1-01-320-0001	Type 4H
OH	Independent overheat prevention device	1-27-001-0021	

DS610

Symbol	Part name	Cord No.	Specification
H	Heater	DS63S-40190	100V, 680W
P	Plug	2-13-001-0008	T2-3b-0
PIO	Display board	1-24-000-0024	Model HiTEC IV CR
PLANAR	Planar board	1-24-000-0023	Model HiTEC IV CR
SSR1	Solid-state relay	2-16-000-0010	SSR-01.
ELB	Bleaker	2-06-005-0011	BJS-203
TF	Transformer	2-18-000-0023	AC200V, HiTEC IV CR
T4	Terminal block	2-07-000-0004	F1112-250-6-4P
TH	Thermocouple	1-16-001-0023	K-thermocouple (double sensor)
X1	Relay	2-05-012-0011	G2R-1A-T-12DC
POWER1	Power board	1-24-000-0025	HiTEC IV CR
CT	Current transformer	2-17-001-0002	CLT-6-S-400
SW	Sheet switch	1-01-320-0001	Type 4H
OH	Independent overheat prevention device	1-27-001-0021	